



# QUALITY CONTROL & PACKAGING

---

STANDARD SOLUTIONS



WOVEN | KNITS





Since 1999, **Yash** has empowered various textile brands in India and across the world through its perceptive outlook and technological expertise. Whether it is Woven, Nonwoven, Carpets or any other application, we have transformed challenges into opportunities and delivered solutions with advanced technologies that enable textile giants to meet their aspirations.

---





## WOVEN



## KNITS

<b>Quality Control</b>	<b>03 - 06</b>
<b>Rewinding</b>	<b>07 - 08</b>
<b>Preparation</b>	<b>09 - 09</b>
<b>Packing</b>	<b>10 - 10</b>
<b>Customized Plants</b>	<b>11 - 11</b>

Model: IWS.01 / P,NDR - P(I)

WOVEN

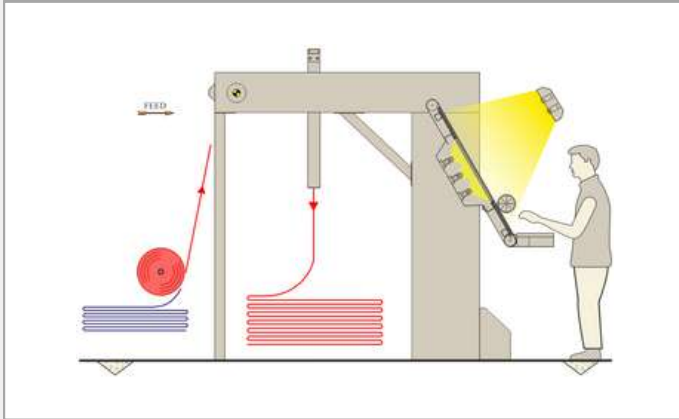

Model: IWS.02 / P,NDR - SWIO

WOVEN

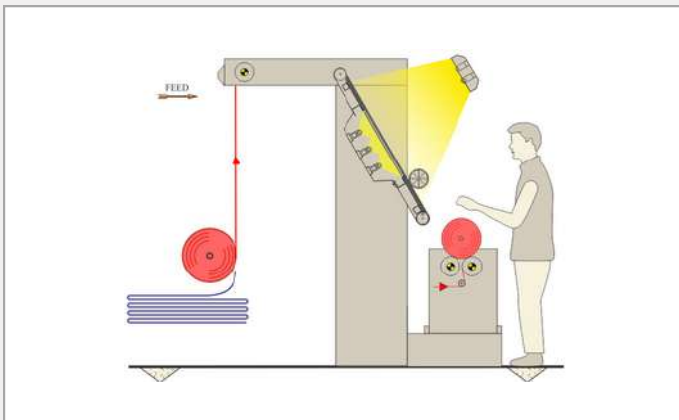

Model: IWS.03 / P,NDR - SWBO

WOVEN

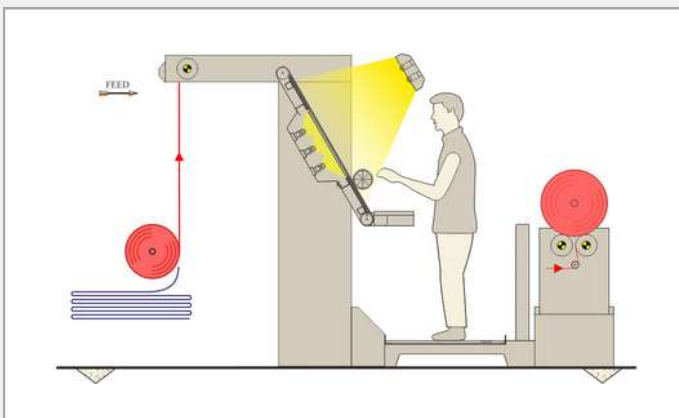



Model: IWS.15 / SU - SWBO

WOVEN

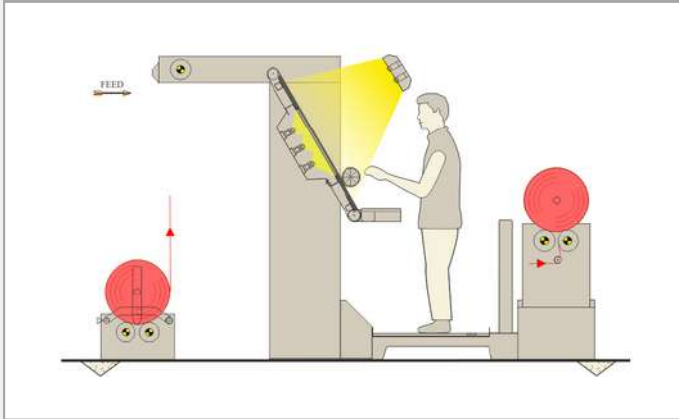

Model: IWS.10 / P,SUBB - SWBB

WOVEN

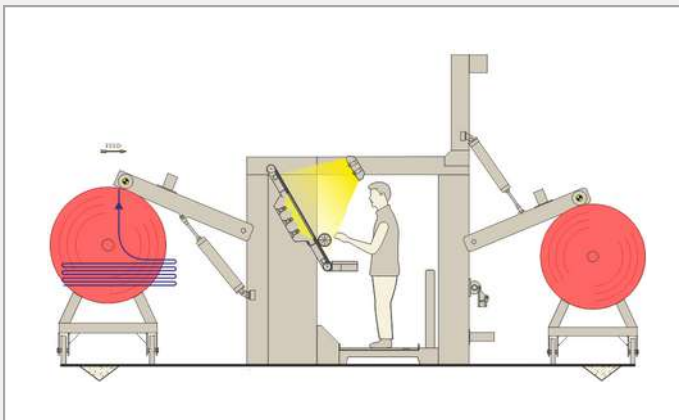

Model: IWS.09 / P,SUBB - SWBO

WOVEN

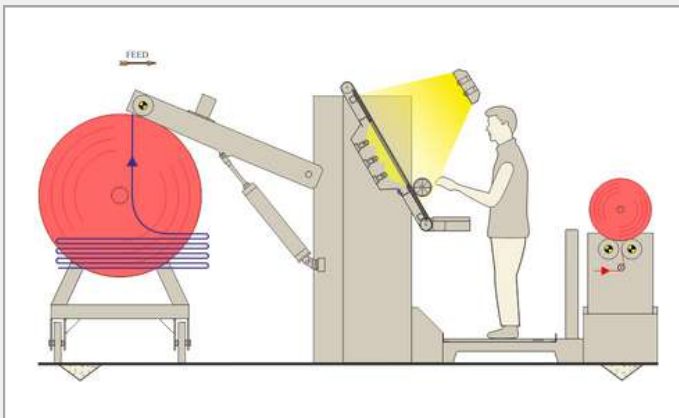

## Tubular Knits (Single Face) Model: ITK.1F.02 / SU - SRSW

KNITS

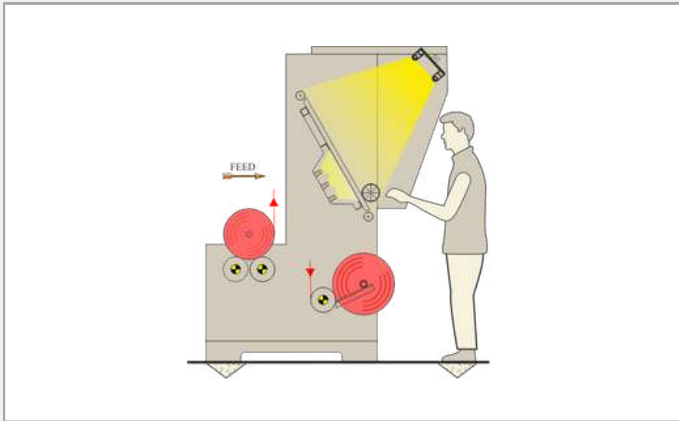

## Tubular & Open Width Knits (Single Face) Model: ITK.1F.04 / SU - SW, SRSW

KNITS

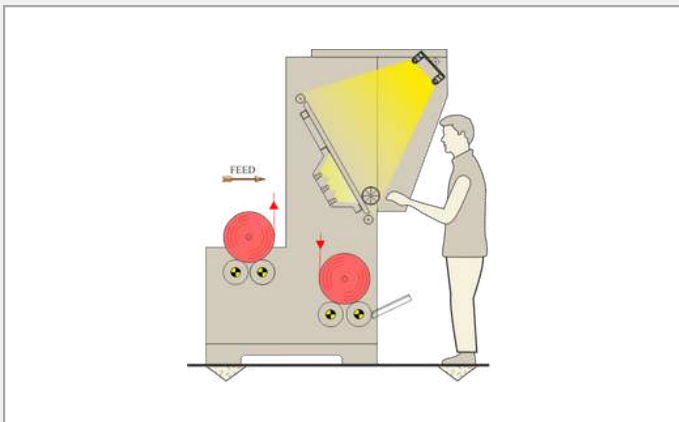

## Tubular Knits (Two Face) Model: ITK.2F.02 / SU - SRSW

KNITS

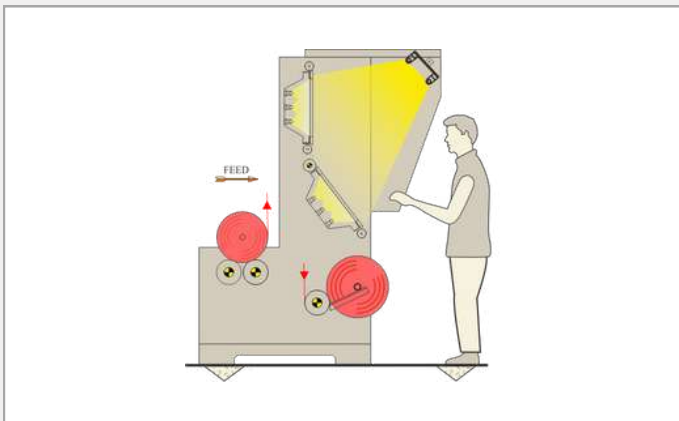

## Tubular & Open Width Knits (Two Face) Model: ITK.2F.03 / SU - SW, SRSW

KNITS

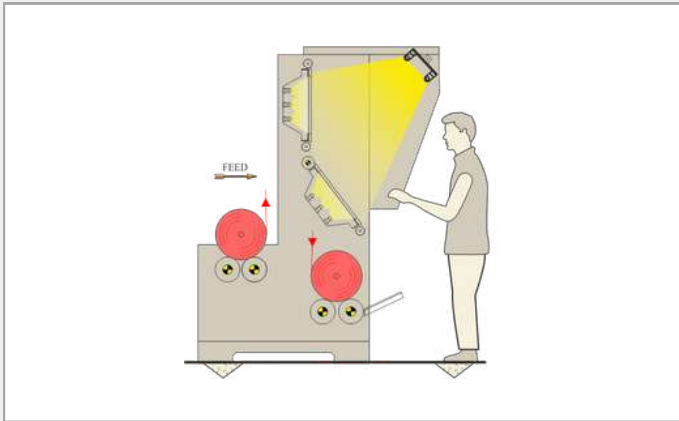

## Open Width Knits Model: IOK.06 / P, SU - SWIO

WOVEN

KNITS

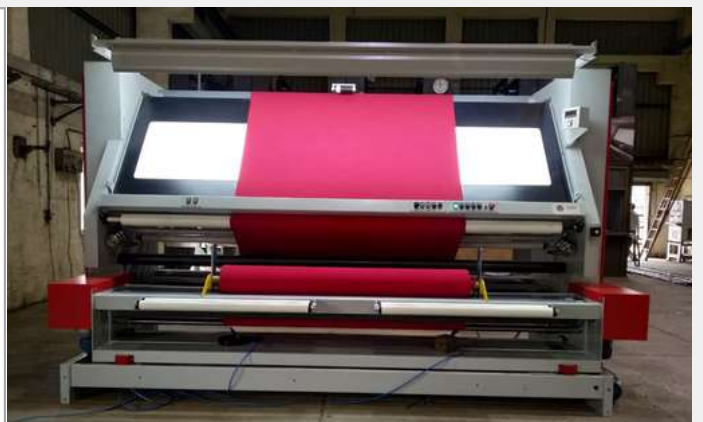
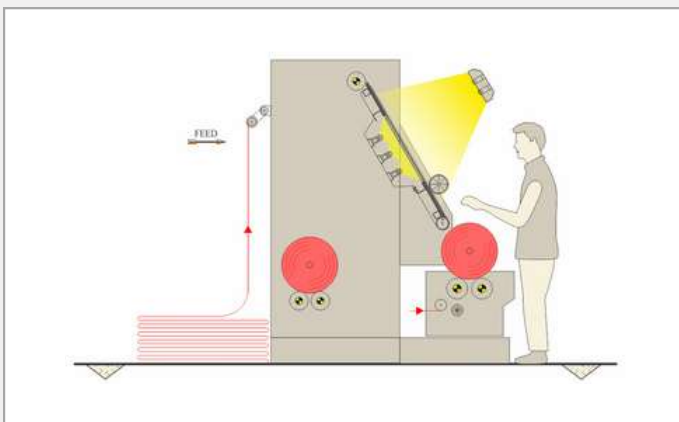

## Open Width Knits Model: IOK.08 / P, SU - SWIO, P

WOVEN

KNITS

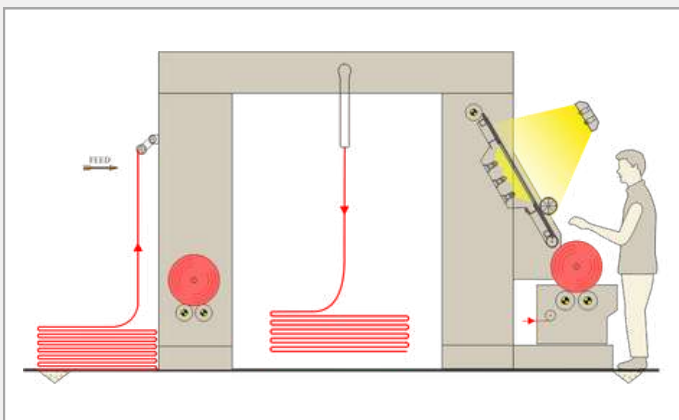



# REWINDING

Model: RWS.01 / P - SW

WOVEN

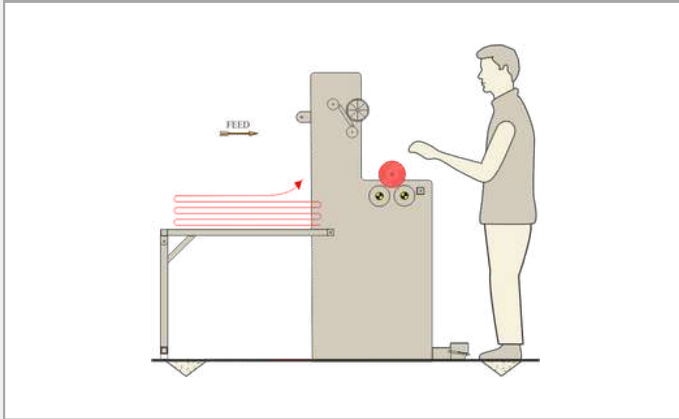

Model: RWS.03 / NDC - SWIO

WOVEN

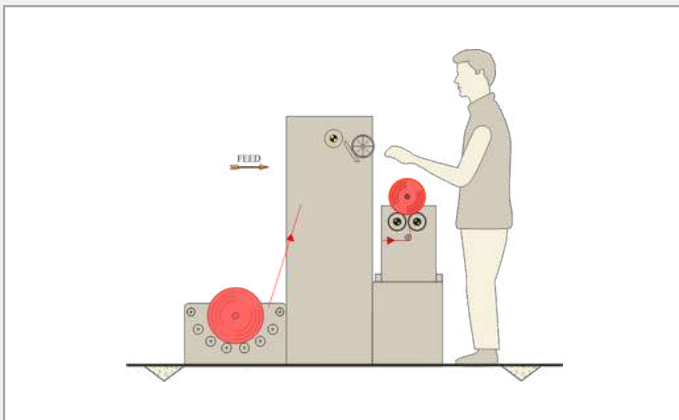

Model: RWS.08 / P, NDR - SWIO

WOVEN

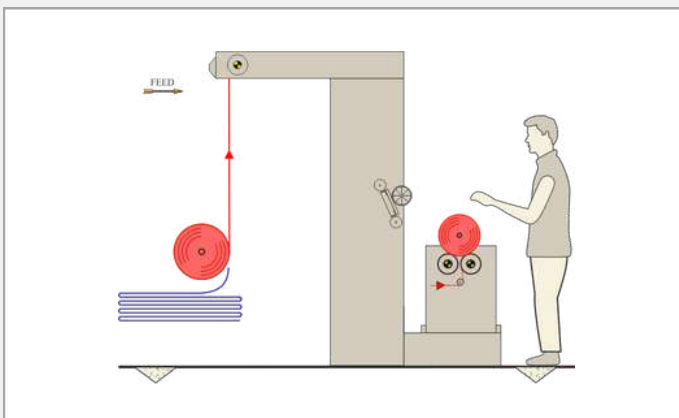



# REWINDING

Model: RSI.01 / NDC - SW

WOVEN

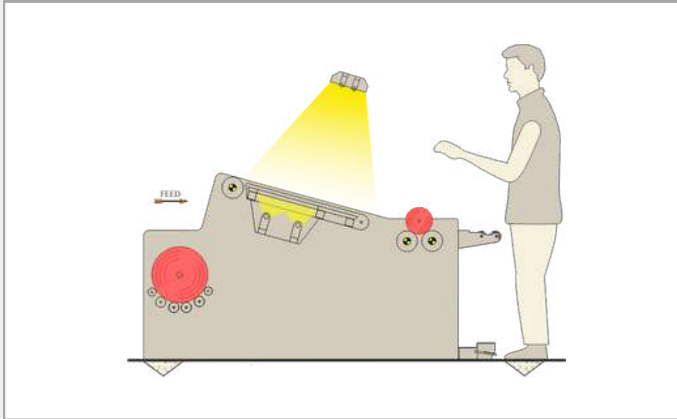

Model: RSI.02 / NDC - SWIO

WOVEN

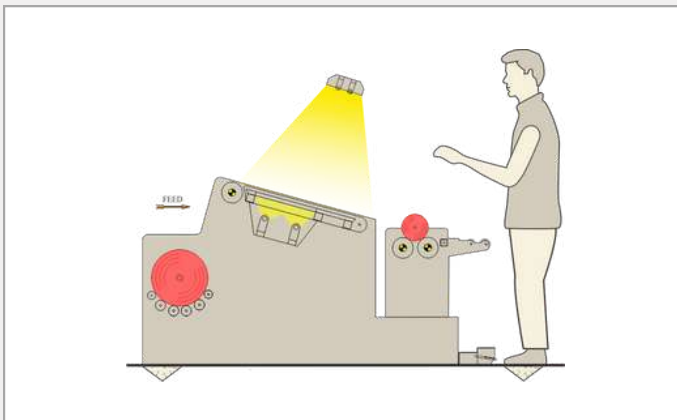

Model: RSI.03 / SU - SWIO

WOVEN

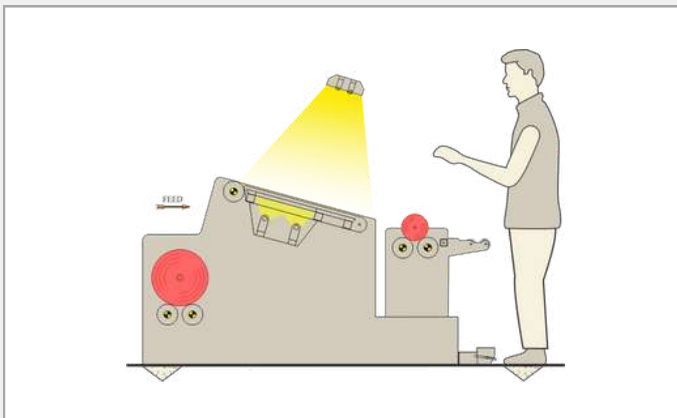

# PREPARATION

Model: BPA.02 / NDR - SWBB

WOVEN

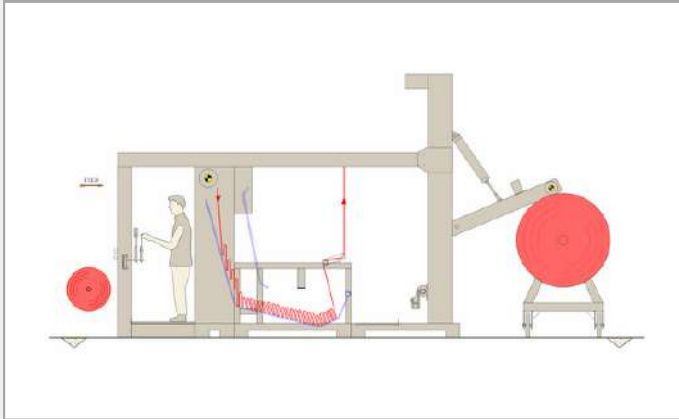

Model: ROW.02 / NDC - P

WOVEN

KNITS

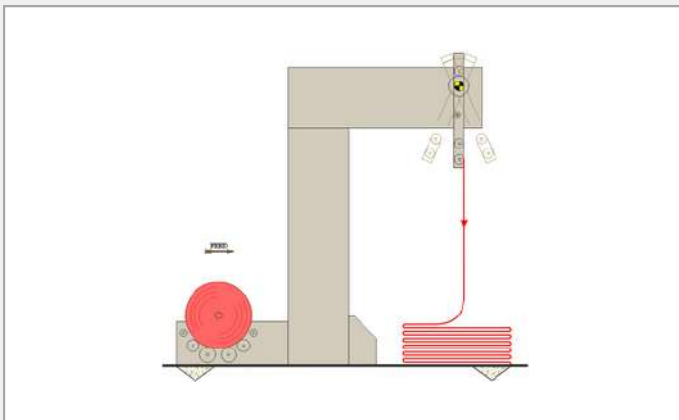

Model: BPK.01 / SU - P

KNITS

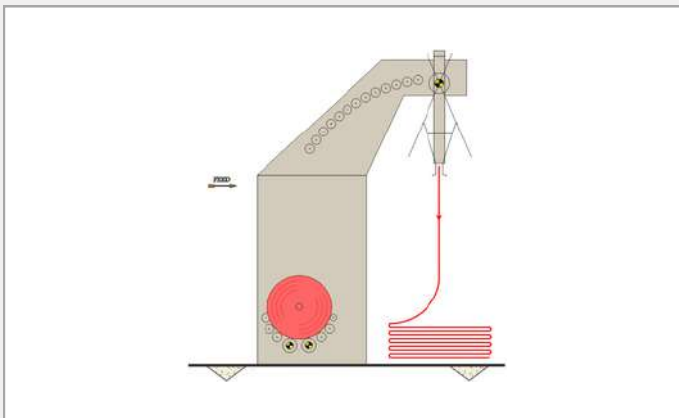



## Roll Stretch Wrapping Machine Model: STP

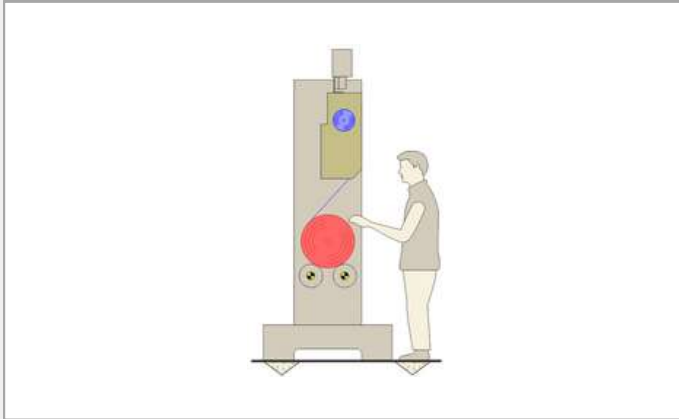

## Fully Automatic (Poly Film) Packing Machine Model: FAP100 / LS+2SS

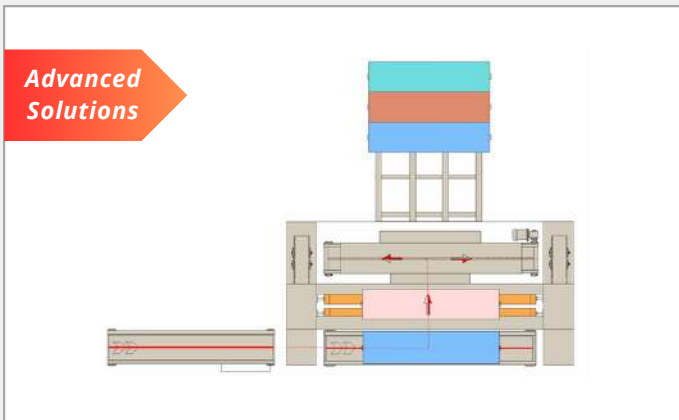

## Fully Automatic (Poly Film) Packing Machine Model: FAP200 / LS+HAB



## Quality Control And Roll Stretch Packing Line

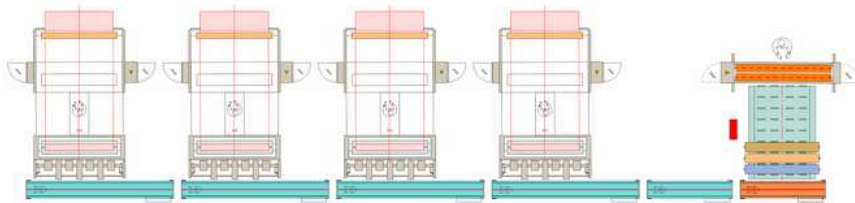

## Automatic Roll Sorting System

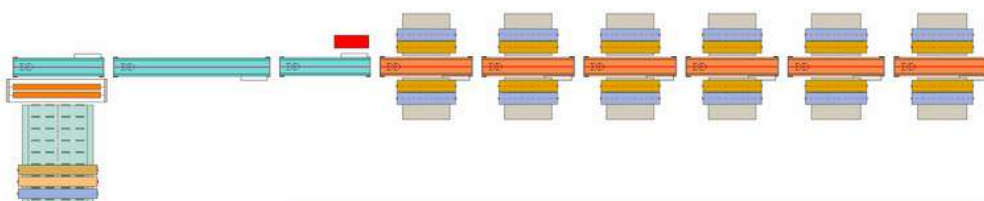



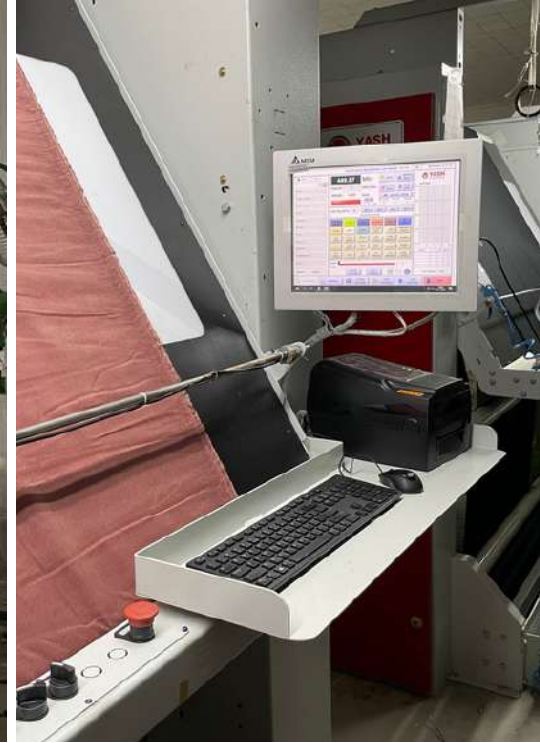

# ADVANCED SOLUTIONS

CONTACT US

## WOVEN



### QUALITY CONTROL AND PACKING

Quality Control and Rewinding  
Packing

### CUSTOMIZED PLANTS

Advanced Grey Fabric Batch Preparation Line  
Finish Fabric Mapping & Cutting Line with Software  
Quality Control and Poly Film Roll Packing Line  
Automatic Roll Handling System  
Automatic Roll Sorting System  
Preparation & Packing for Rolls and Parcels  
Quality Control, Roll Handling & Packing System  
Case Packing and Palletizing System  
Special Lines and Accessories

## NONWOVEN & TECHNICAL TEXTILES



### QUALITY CONTROL

Inspection and Slitting Machine for Nonwovens  
Inspection Machine for Airlaid & Belting Fabrics

### REWINDING

Rewinding and Edge Slitting Machine for Nonwovens  
Non Stop Rewinding and Packing Machine for Nonwovens

### FABRIC FOLDING

Fabric Folding Machine for Nonwovens  
Fabric Folding Machine for Geotextiles

### CUSTOMISED PLANTS

Nonwoven Roll Handling & Packing Line

## CARPETS & FLOOR COVERINGS



### QUALITY CONTROL

Inspection, Rewinding and Packing Line for Carpets

### REWINDING

Carpet Rewinding Machine for Coating Line  
Cut-to-Length Machine for Carpets  
Rewinding and Cutting Machine for Artificial Grass

### PACKAGING

Stretch Film Wrapping Machine for Rolls



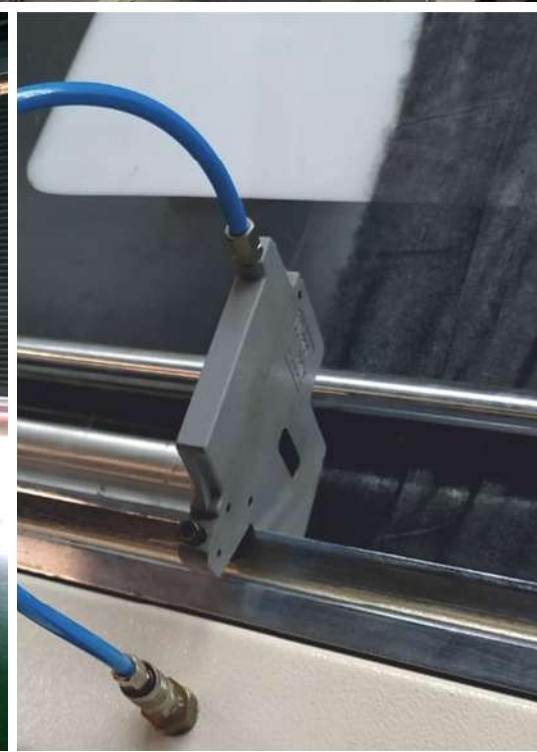



*Since 1999*

---



## **Yash Textile Machines Pvt. Ltd.**

B-91, MIDC, Addn. Ambarnath  
Industrial Area, Anand Nagar,  
Ambarnath (East), Dist. Thane  
421506, Maharashtra, India

✉ sales@yashtex.com | ☎ +91 9167772065

✉ info@yashtex.com

[www.yashtex.com](http://www.yashtex.com)

